

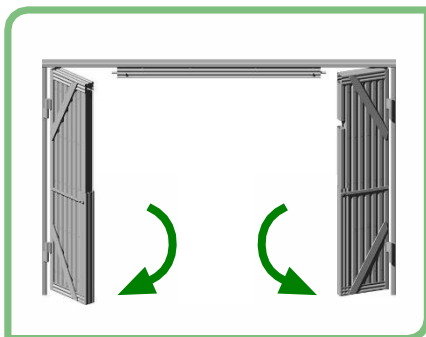

**Puertas
metálicas
de Ballesta**

forsa sur
PUERTAS Y AUTOMATISMOS

Puertas metálicas (visto desde el exterior)



modelo 1
Dos hojas exteriores

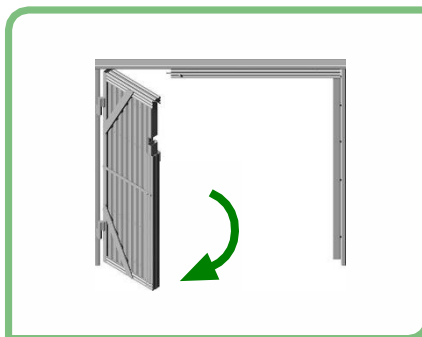

modelo 2
Una hoja exterior izquierda

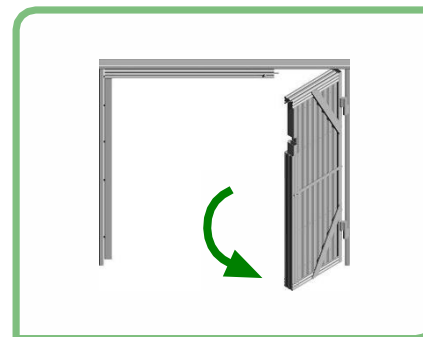

modelo 3
Una hoja exterior derecha

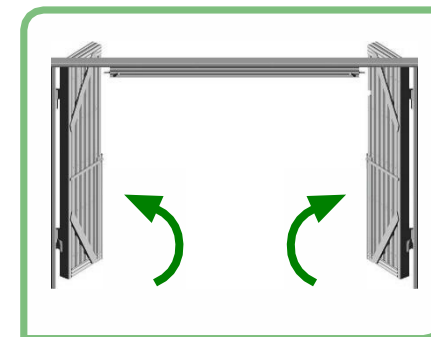

modelo 4
Dos hojas interiores

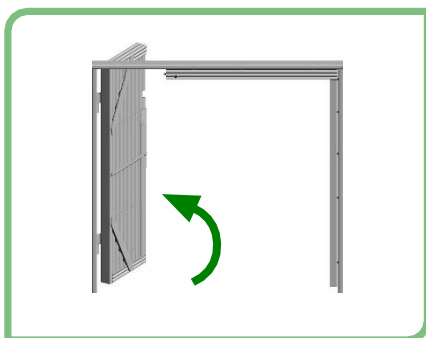

modelo 5
Una hoja interior izquierda

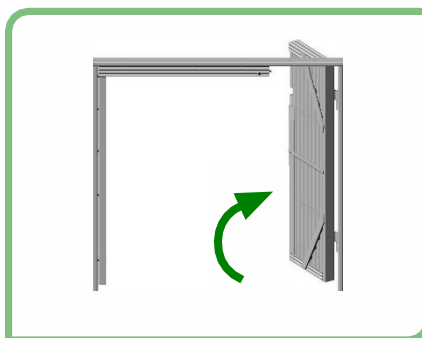

modelo 6
Una hoja interior derecha

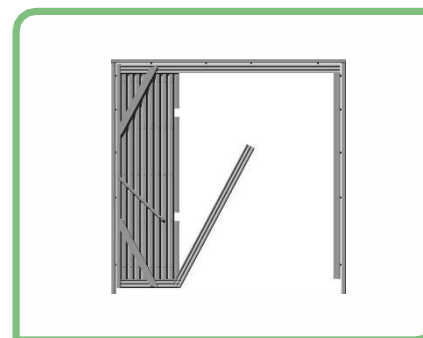

modelo 7
Corredera izquierda,
no abatible, levanta guía

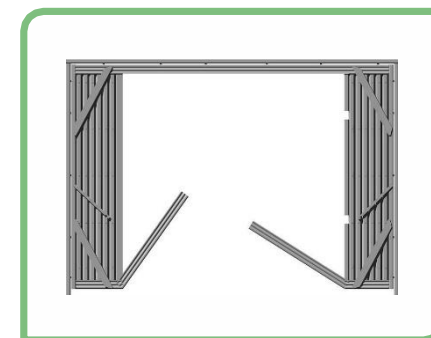

modelo 8
Corredera no abatible,
dos hojas levanta guía

DISPONEMOS DE UNA AMPLIA GAMA DE RALES.

MATERIAL GALVANIZADO TERMOLACADO CON RESISTENCIA A LA OXIDACIÓN Y CON LLAVE DE SEGURIDAD.

Puertas metálicas (visto desde el exterior)

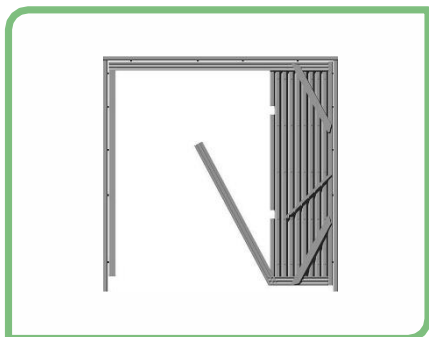

modelo 9
Corredera derecha, no abatible
levanta guía

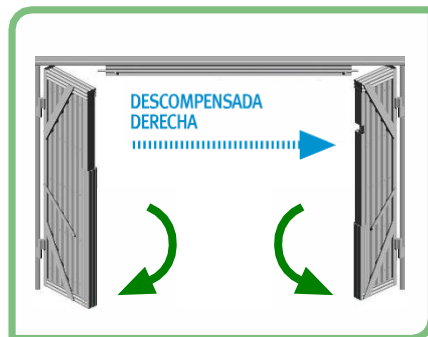

modelo 10
Dos hojas descompensadas
derecha



modelo 11
Dos hojas descompensadas
izquierda

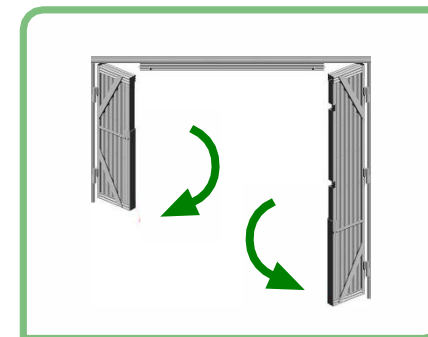

modelo 12
Puerta bandera
(con o sin pilastra)

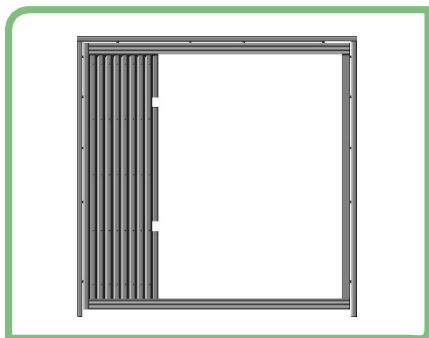

modelo 13
Corredera izquierda, no abatible,
no levanta guía

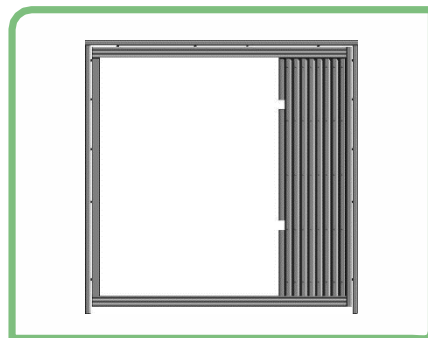

modelo 14
Corredera derecha, no abatible,
no levanta guía

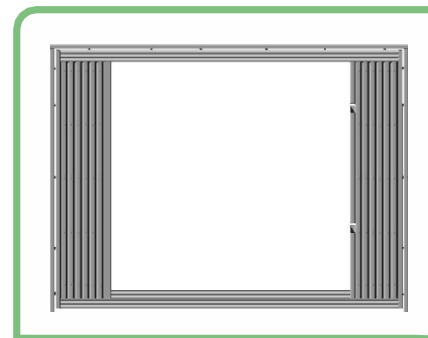

modelo 15
Corredera no abatible,
dos hojas, no levanta guía

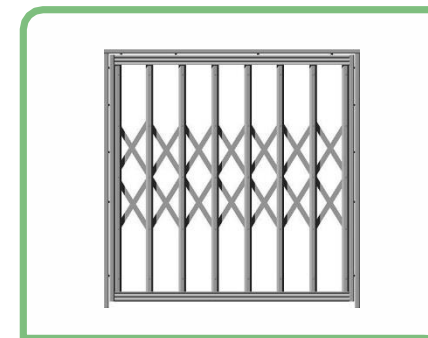

modelo 16
Fija

Rodamientos

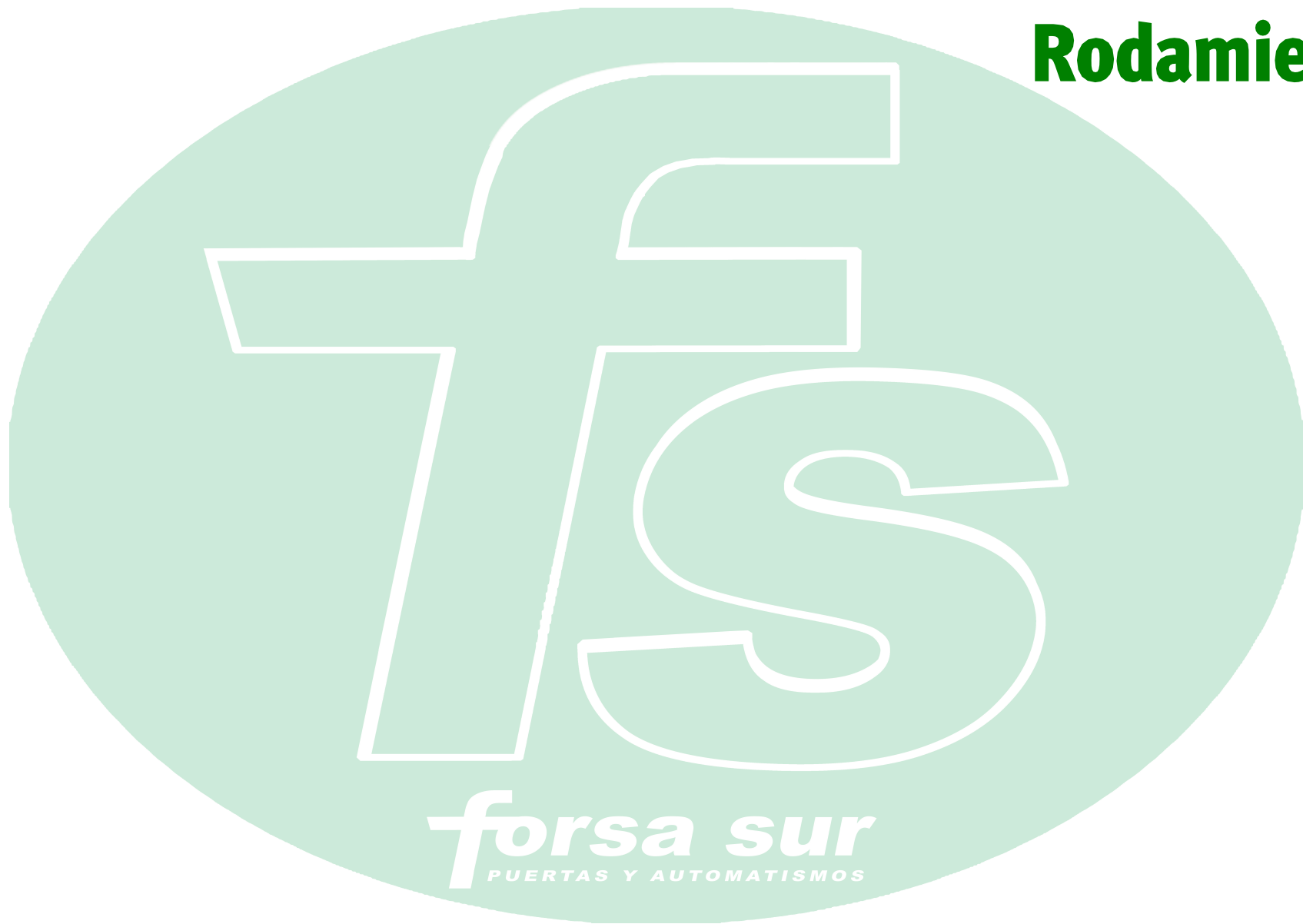

Puertas de ballesta / rodamiento superior

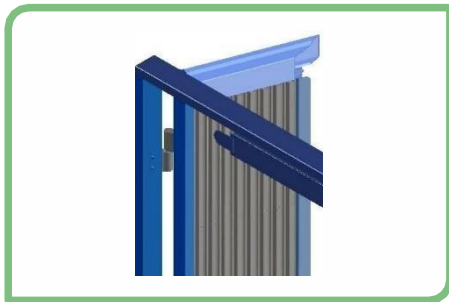

Detalle superior

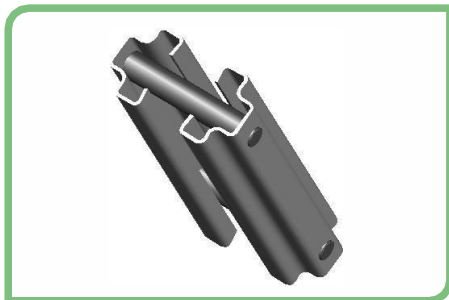

Lama 23

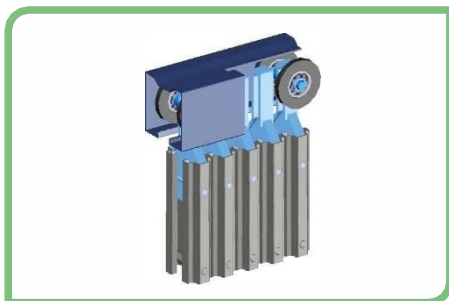

Guía superior

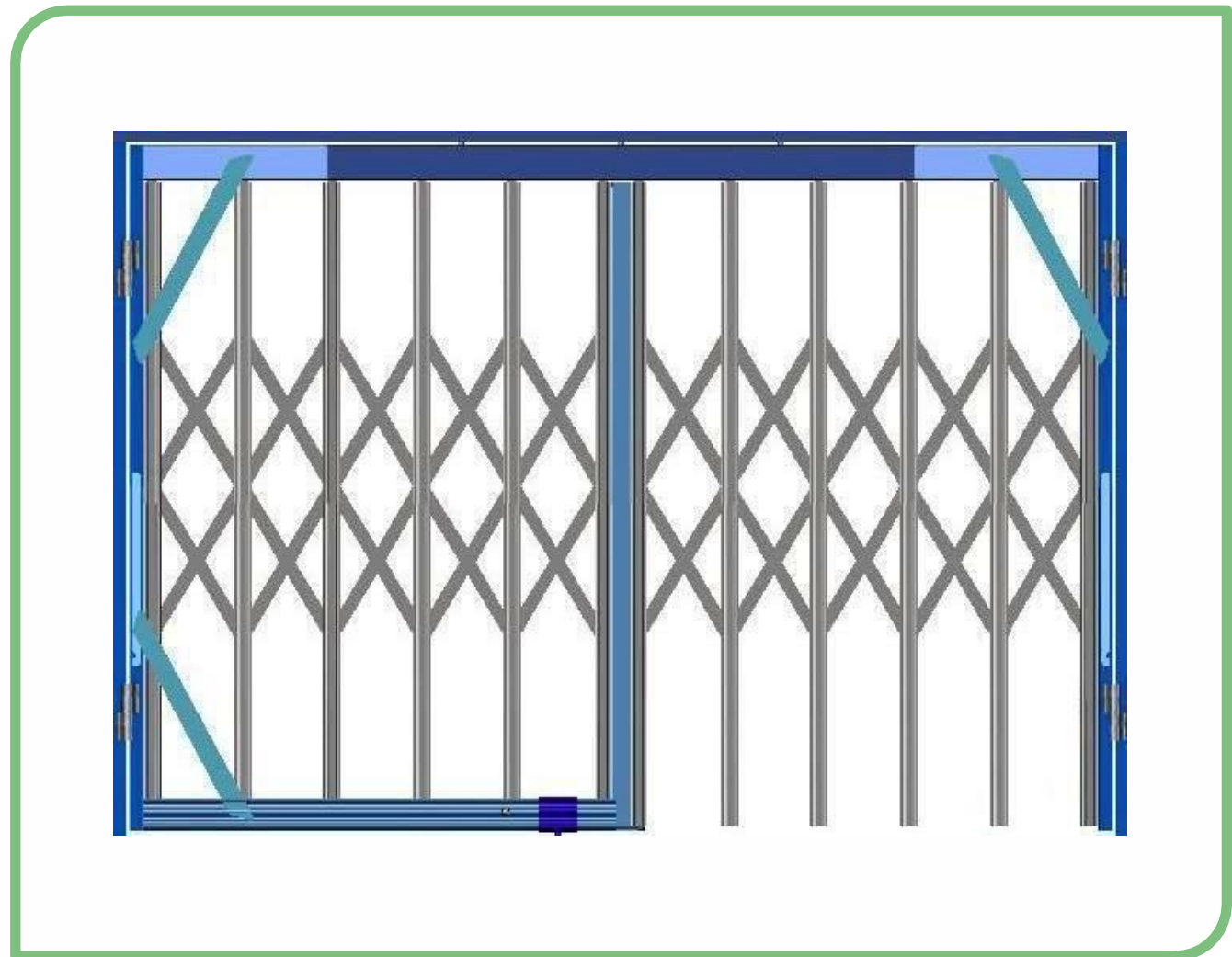

Puertas de ballesta / rodamiento inferior

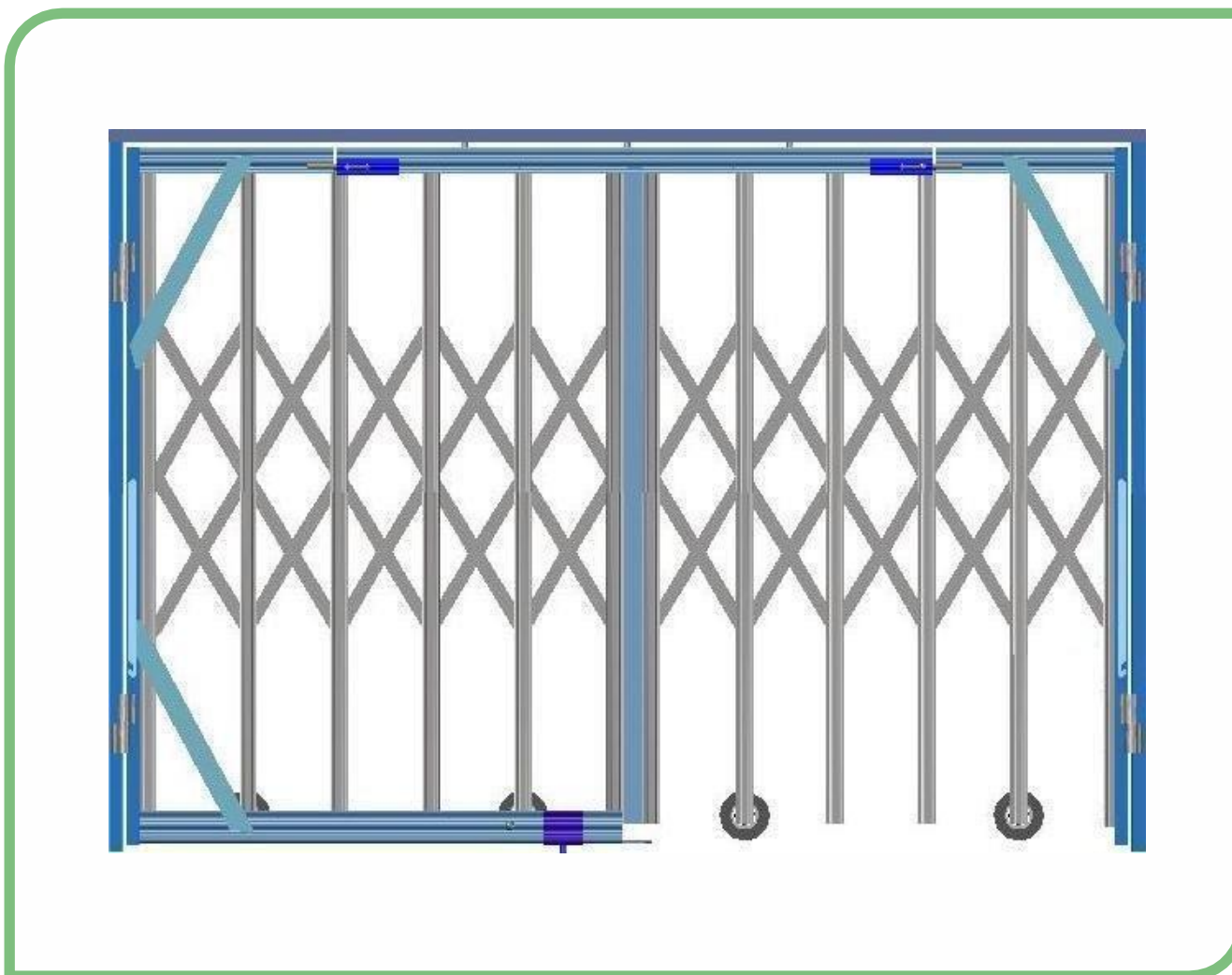

Detalle superior



Lama 23

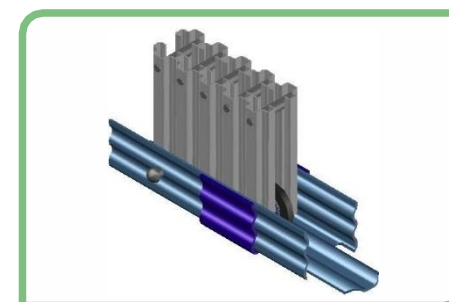

Guía inferior

Sujeciones



Sujeciones puertas de ballesta tipo 1

1.1
Desplaza normal (doble marco)

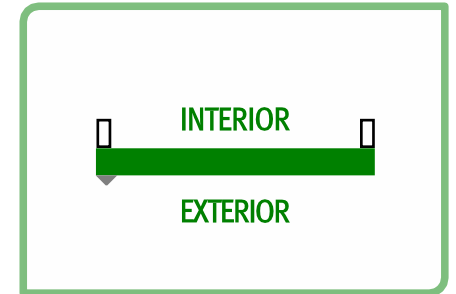
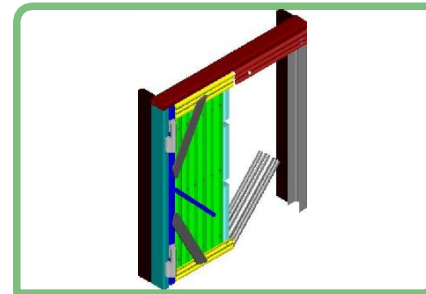
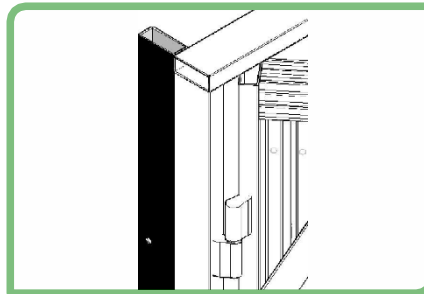

1.2
Desplaza y solapa exterior

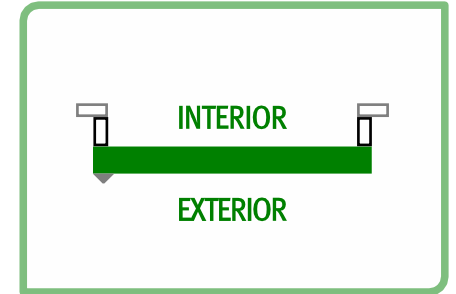
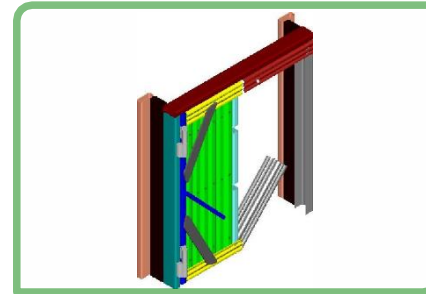
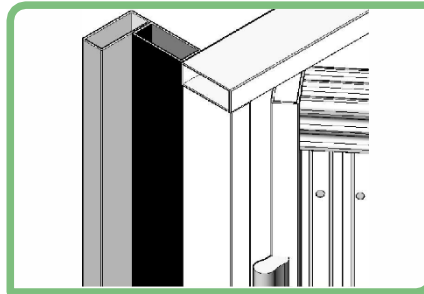

1.3
Desplaza y solapa interior

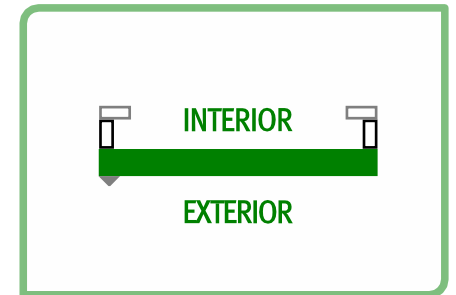
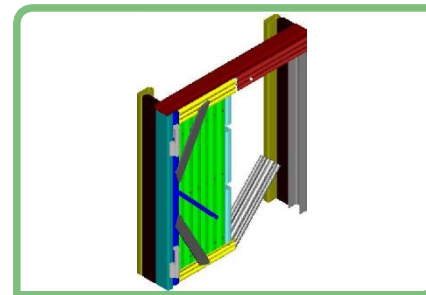
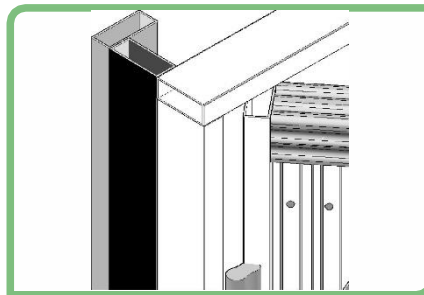

Sujeciones puertas de ballesta tipo 2

2.1
Solapada normal

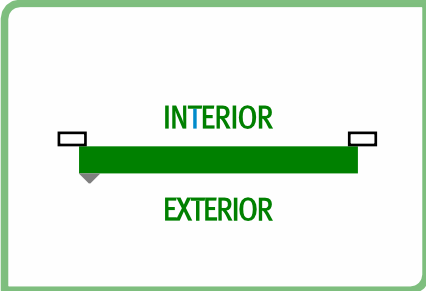
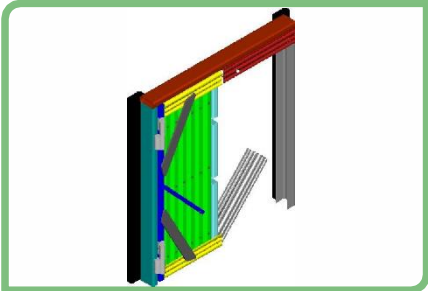
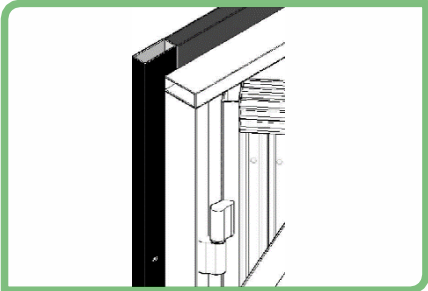

2.2
Solapada a ras (interior)

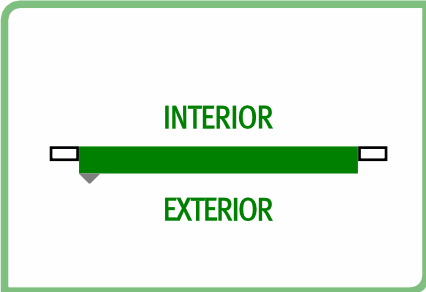
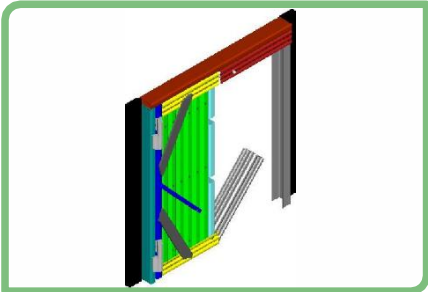
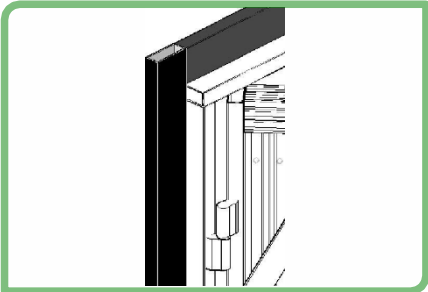

Sujeciones puertas de ballesta tipo 2

2.3
Tubo modo tapajunta

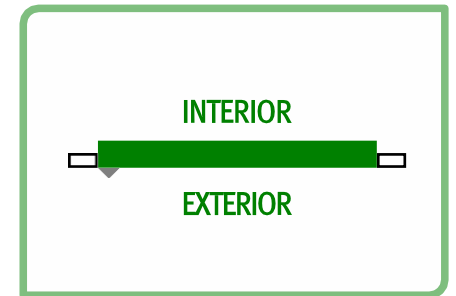
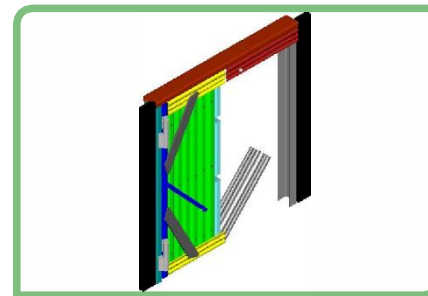
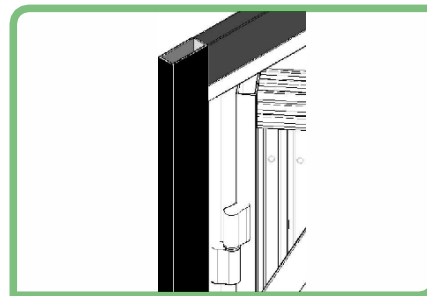

2.4
Solapada centro marco

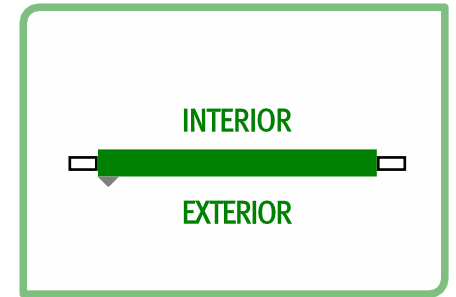
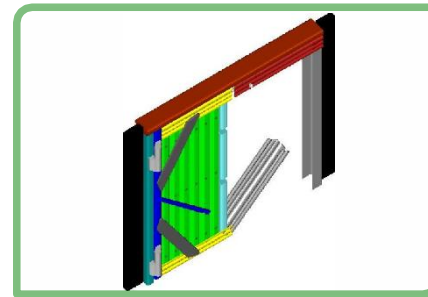
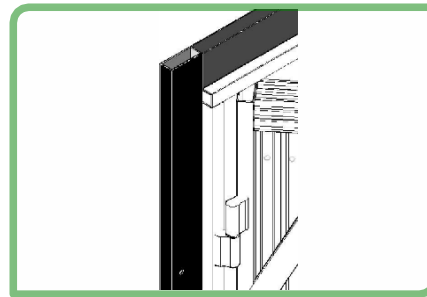

Sujeciones puertas de ballesta tipo 3

3.1
Orejetas solapadas

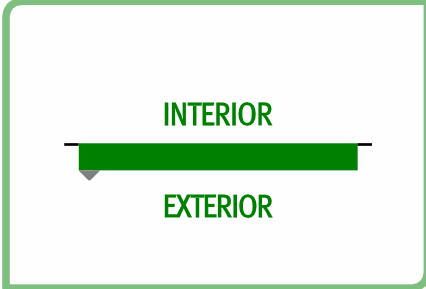
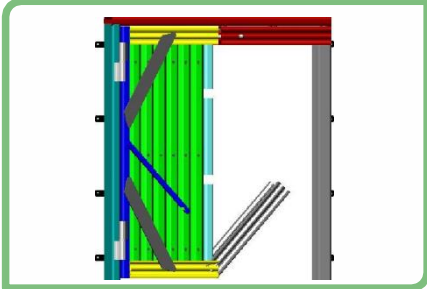
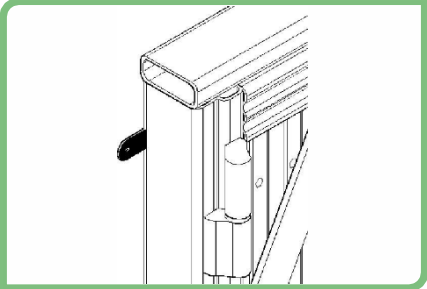

3.2
Orejetas doble marco

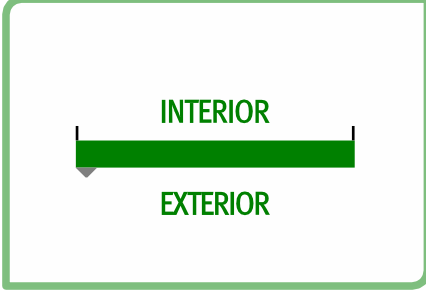
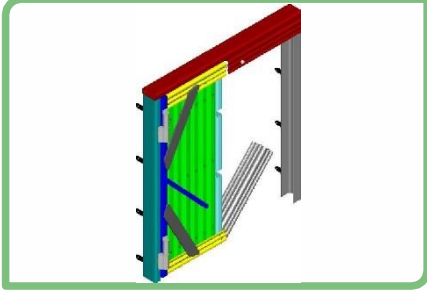
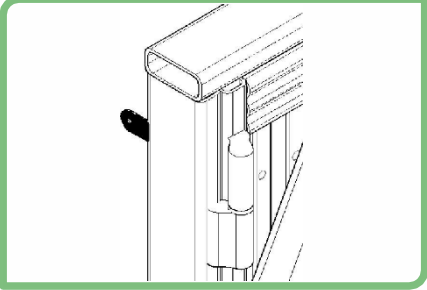

3.3
Orejetas modo tapajuntas

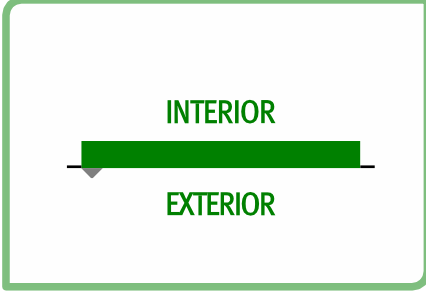
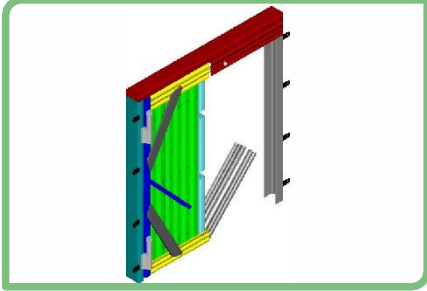
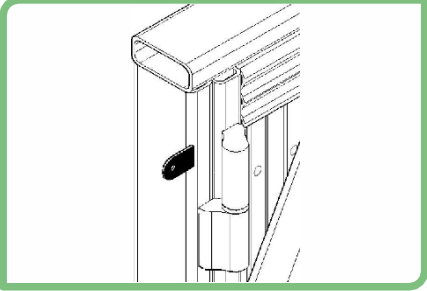

Sujeciones puertas de ballesta tipo 3

3.4
Orejetas centro marco

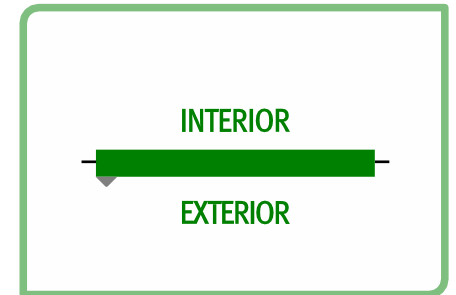
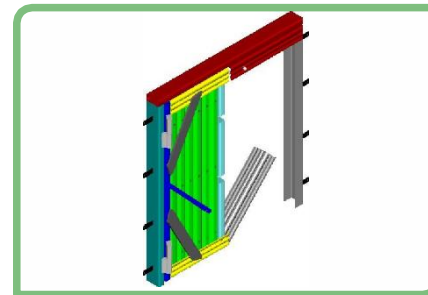
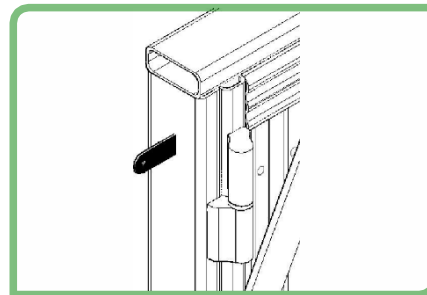

3.5
Orejetas desplazadas y solapadas

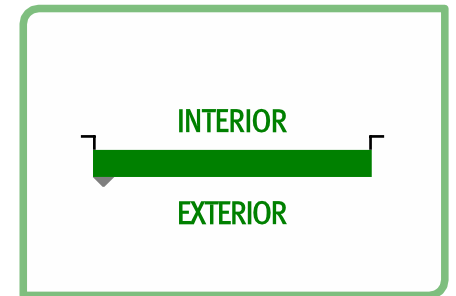
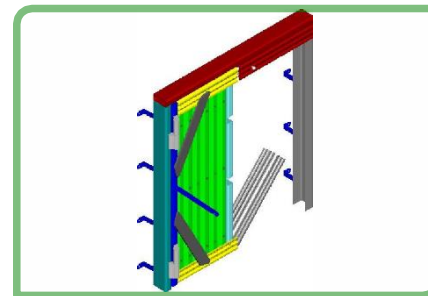
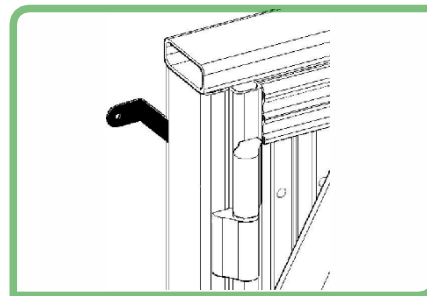

Sujeciones puertas de ballesta tipo 4

4.1
Garras normales

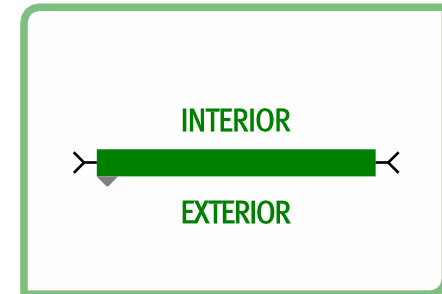
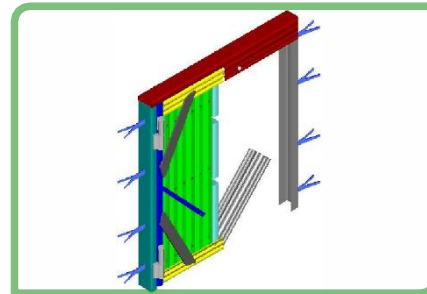
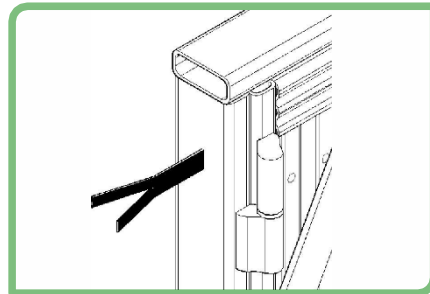

4.2
Garras doble marco

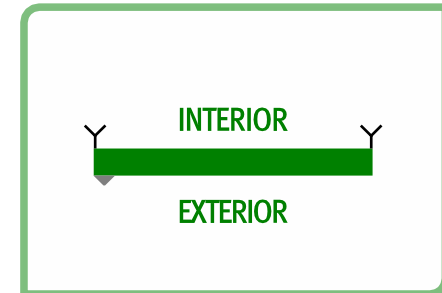
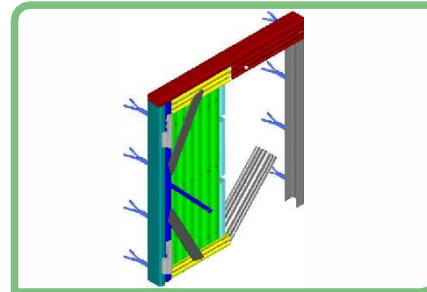
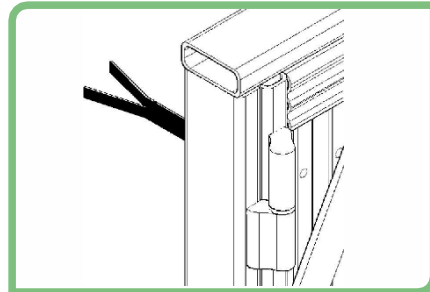

4.3
Garras inclinadas
hacia dentro

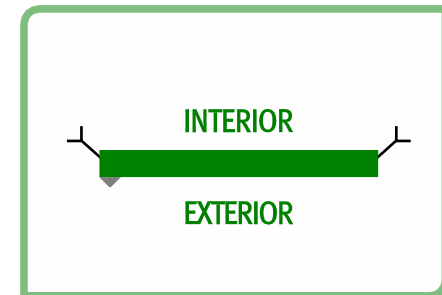
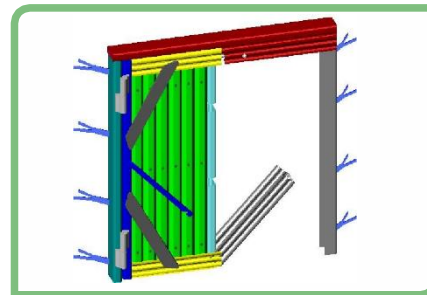
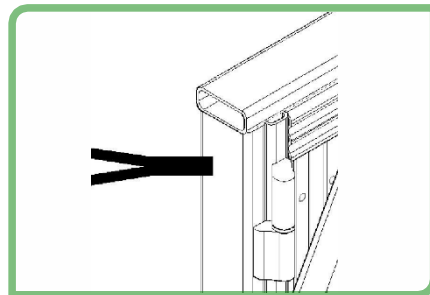

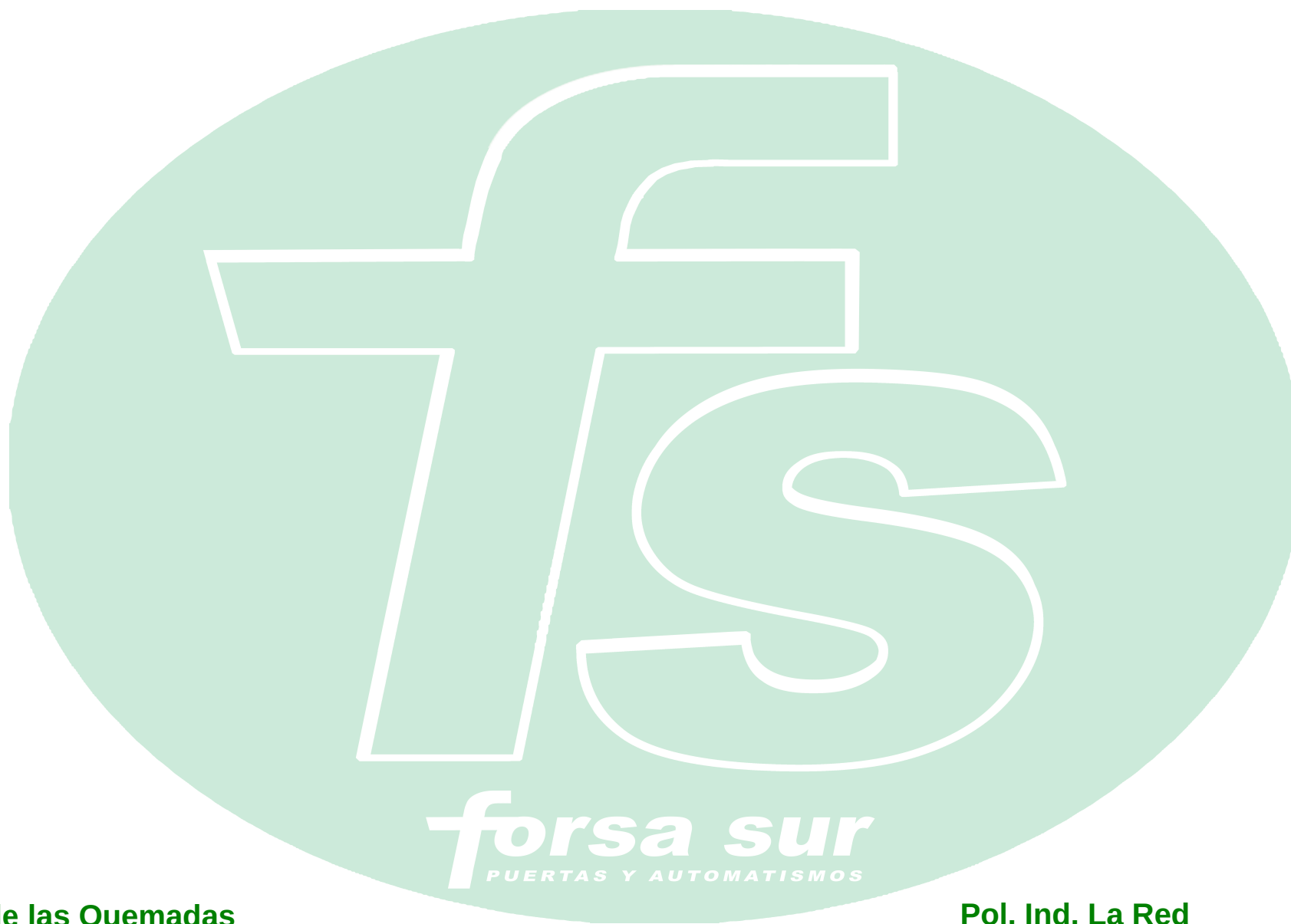

Pol. Ind. de las Quemadas
Cl. José Gálvez y Aranda, parc. 31-32 nº4
14014 - Córdoba (Córdoba)
957 32 67 29 - cordoba@forsasur.es

Pol. Ind. La Red
Cl. Seis, parc. 50 nº29
41500 - Alcalá de Guadaría (Sevilla)
955 63 44 96 - sevilla@forsasur.es